



Wireless Thermostat

Made in USA

Installation Instructions

Model T200WL01



Applications

- Automatic control of airflow based on temperature setpoint.

Features

- Set the temperature best suited for your comfort and the thermostat will adjust the airflow to insure the space is not overcooled or overheated.
- Over-conditioned airflow is automatically redirected to spaces that need it.
- Use the Nighttime feature to automatically reduce airflow at night.
- Automatically lower airflow on days the facility is closed.
- Manual or 7-day programmable operation.
- Battery operated. Requires no wiring.
- Large, backlit LCD display.

Operation	Automatically controls airflow based on temperature setting, space temperature and supply air temperature.
Sensor	Temperature sensor at the WCD damper senses heating or cooling calls.
Dampers	WCD Dampers / A80-WL Wireless Actuator
Airflow Control	100% to 0% or minimum airflow set by mechanical stop on the actuator.
Zones	1 zone can control up to 32 different dampers.
Addresses	32 different addresses for different departments, groups or floors.
Schedule Mode	Programmable start and stop times for daytime operation using automatic airflow control based on temperature setting.
Hold Mode	Automatic airflow control based on temperature setting 24/7.
System Modes	Off or Auto. In Auto, airflow is controlled by temperature setting. In Off, the airflow is reduced to the preset Off level.
LCD Backlight	The LCD backlight is turned on whenever a key is pressed.
Wireless Control	Uses 915MHz ISM band with proprietary protocol. Indoorangeisover100feet.
Battery Powered	Uses two AA batteries.
Dimensions	5.00 x 4.50 x 1.00 inches (LWD)



Operation

The thermostat communicates with the wireless damper actuator via an RF wireless data link. It monitors the space temperature and the setpoint temperature and sends data to the damper telling it how many degrees the space temperature is above or below the temperature setting.

The actuator has a temperature sensor that monitors the supply air temperature to determine if the HVAC system is or has been calling for heating or cooling. The damper then opens or closes proportional to the temperature differential it received from the thermostat.

The thermostat periodically adjusts the airflow. The interval can be set from 5 to 30 minutes. The change in airflow can be set to either 8% or 16% per degree of temperature differential.

Improved Comfort

The wireless thermostat and damper are used to automatically control airflow to maintain a comfortable temperature and eliminate the annoying overcooling and overheating found in many work areas, offices, restaurants and other spaces.

Energy Savings

Excess airflow that caused the overcooling or overheating is automatically redirected to areas that need it and the thermostat is satisfied sooner, resulting in less operating time for the HVAC system.

The thermostat has an Off position that can shut the airflow down when the office or space is not being used and provide even greater energy savings. The night setback feature works the same way and provides added energy savings.

1 Mechanical Bypass

The WCD Damper actuator has a Close position limit that can be used to insure a minimum airflow even when the thermostat tries to fully close the damper. The minimum Close position can be set from about 50% closed to fully closed.

This should be used when a large number of WCD Dampers are used with the same HVAC system to insure that static pressure does not damage the ducts.

See the Installation Instructions supplied with the WCD Damper for setting the Close position limit.

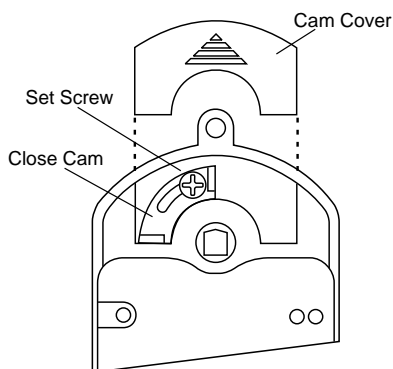

2 Remove the Sub-base Before Installation

Hold the sub-base with one hand, press the case as shown below and pull the bottom of the thermostat from the sub-base.

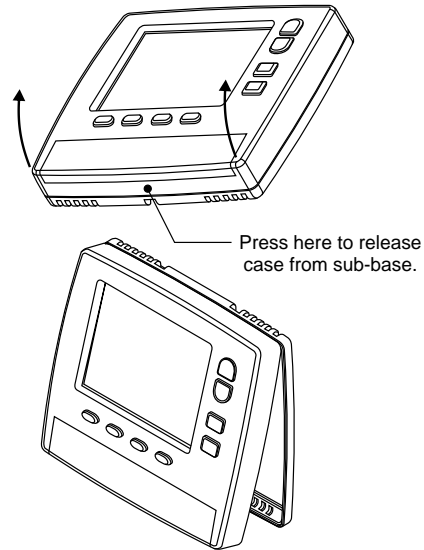

3 Installing the Sub-Base

The thermostat can be installed on any interior wall approximately 5 feet above the floor. To insure accurate reading of the space temperature, the thermostat should not be in direct sunlight.

Install the sub-base using two #8 or #6 sheet metal screws with wall anchors where required. Level the thermostat for appearance.

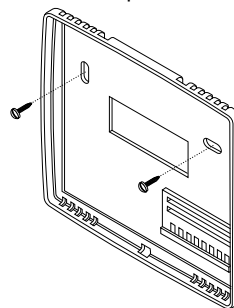

4 Installing the Batteries

Slide the battery cover off and install two AA lithium or alkaline batteries. Install the batteries with the positive terminals to the right as shown. Replace the battery cover.

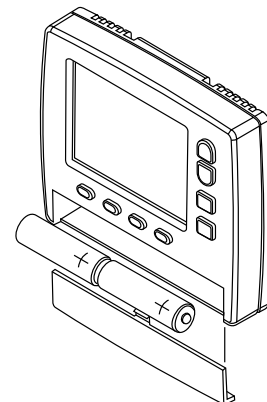



5 Accessing the Installation Options

Installer options can be accessed by pressing and holding the unmarked key below the System key for seven seconds. The LCD will display Option 01 for setting the Zone number.

Press or hold the Next key to advance to the next option. The LCD will advance to Option 11 and return to Option 01. Press the Cancel key to exit the option selections. Press the Enter key to save all options in non-volatile flash ram.

Option	Description	Default
01	Zone number Range 1 to 32	1
02	Address number Range 1 to 32	1
03	Program Damper with Zone and Home address	na
04	Dead-band Differential Range 1 to 5°F	1°F
05	Update interval Range 5 to 30 minutes	10 minutes
06	LCD back-light control Range 0- On with key	On with key stroke
07	High setpoint limit Range 60 to 90°F	80°F
08	Low setpoint limit Range 55 to 80°F	65°F
09	Damper factor Range 0- 8%/F 1-16%/F	0- 8%/F
10	Night airflow Range 0 to 100%	50%
11	Off airflow Range 0 to 100%	50%

601 Option 01 Setting Zone Number Default= 01

If only one wireless thermostat is used in the installation, the default Zone 01 and Home 01 can be used. Skip to setting Option 04. If multiple wireless thermostats are used, each thermostat and module have to be programmed with a unique Zone number. The first thermostat can use the factory set Zone 01 and Home 01 address.

Use the Up and Down keys to set the Zone number for the other thermostats. The Zone number can be set from 1 to 32.

Press the Next key to advance to the next option. Press the Enter key if no more options are to be changed. Or press the Cancel key to exit the option sequence and return to normal operation.

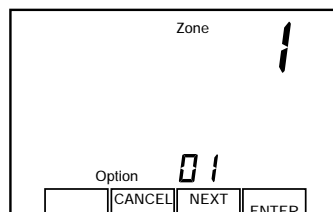

602 Setting Home Number Default= 01

The Home address is used to distinguish between installations that are less than 500 feet away. This allows neighbors, different departments or floors to use the wireless thermostats and not interfere with each other. Skip to Setting Option 04 if no other user groups are nearby.

Use the Next key to select Option 02. Use the Up and Down keys to set the Home number for this thermostat. The Home number can be set from 1 to 8. If multiple departments are installing wireless thermostats, each department should use a different Home number to insure a WCD Damper in another department is not inadvertently changed.

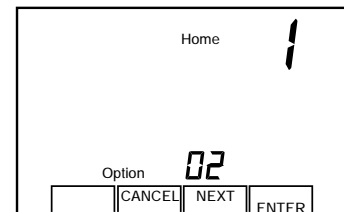

603 Programming Wireless Damper

After selecting the Zone and Home numbers for the thermostat, the same address must be set into the WCD Damper actuator. First press the Program key on the actuator. The actuator will accept a new address for thirty seconds. The LED will alternately blink red and green while it is waiting for a new address. Wireless damper actuators are shipped with default address Zone=1 and Home=1.

Press switch to enable programming Zone and Home number.

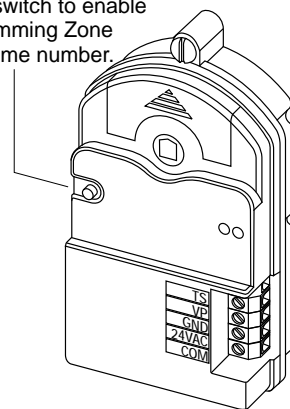

The LCD display for Option 03 is shown below. Press the Enter key to send the new address to the WCD Damper actuator. The damper will now only respond to the thermostat with the same address.

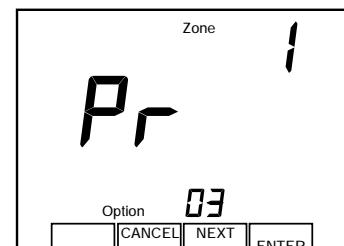



604 Setting Deadband Temperature Default= 1 Degree

The difference between the setpoint and room temperature must exceed the deadband temperature before the thermostat makes an adjustment to the airflow. If the deadband is set for 1 degree, the room temperature must be more than 1 degree warmer or cooler than the setpoint temperature before the damper position is changed

Use the Next key to select Option 04 and use the Up and Down keys to set the Deadband Temperature. Range is 1 to 5 degrees. Press the Enter key to save the setting.

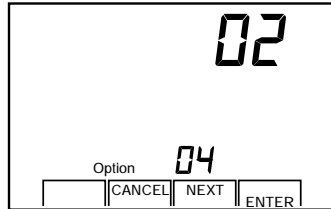

605 Set Update Time Interval Default= 10 Minutes

The Update Time Interval determines how often the thermostat sends data to the wireless damper actuator. Shorter times will use more battery life and provide faster response to temperature changes. The default setting of 10 minutes is a good compromise in battery life and responsiveness.

Use the Next key to select Option 05. Use the Up and Down keys to set the Update Time from 5 to 30 minutes. Press Enter to save the setting.

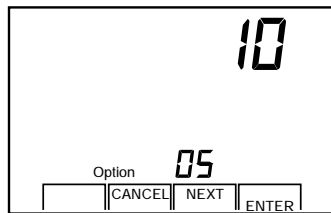

606 Set LCD Lighting Default= On with Key

The LCD uses LEDs to light the display. Battery operated thermostats light the LCD is only when a key is pressed. Option 06 is set to 00 and cannot be changed.

Use the Next key to advance to Option 07.

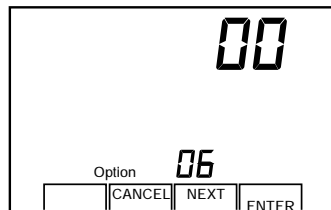

607 Set High Setpoint Limit Default= 80 Degrees

The High Setpoint Limit is the highest setpoint temperature the user can set.

Use the Next key to select Option 07. Use the Up and Down keys to set the High Setpoint Limit. The limit can be set from 60 to 90 degrees.

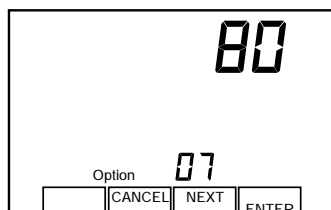

608 Set Low Setpoint Limit Default= 65 Degrees

The Low Setpoint Limit is the lowest setpoint temperature the user can set.

Use the Next key to select Option 08. Use the Up and Down keys to set the Low Setpoint Limit. The limit can be set from 55 to 80 degrees.

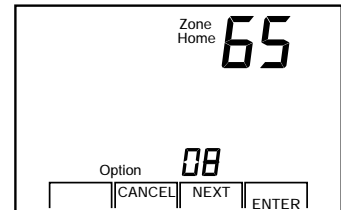

609 Set Damper Factor Default= 8%/Degree

The WCD Damper position is adjusted proportional to the differential between setpoint and room temperatures. The Damper Factor is the percent change in damper position or airflow for one degree of temperature differential.

Use the Next key to select Option 09. Use the Up and Down keys to select 8% or 16% change in damper position per degree in temperature differential. Press the Enter key to save the selection.

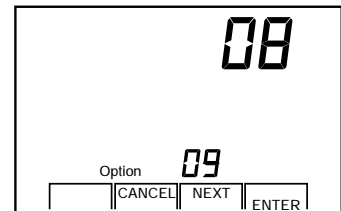

610 Set Nighttime Airflow Default= 50%

The Nighttime Airflow is the airflow level that is automatically set when using the scheduled nighttime setback. The lower airflow will reduce energy consumption.

Use the Next key to select Option 10. Use the Up and Down keys to set the Nighttime Airflow from 0 to 100%. Press Enter to save the setting.

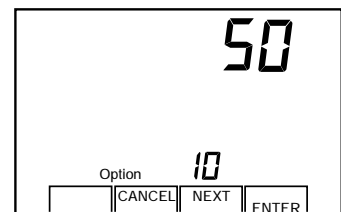

611 Set OFF Airflow Level Default= 50%

The Off Airflow is the airflow level that is automatically set when the System is set to Off. The lower airflow reduces energy consumption.

Use the Next key to select Option 11. Use the Up and Down keys to set the Off Airflow from 0 to 100%. Press Enter to save the setting.

